

# Operative technique



**ESTREMO**  
Fibular Nail

Fibula intramedullary nail

The information herein is intended to describe the product. Surgeons must always decide the best approach to follow based on their clinical judgement and the patient's needs. Before use, the surgeon should always refer to the instruction manual included in the product package.

Before use, consult the instruction manual included in the product package.

## CONTENTS

PRODUCT DESCRIPTION .....	4
SURGICAL INDICATIONS AND ENTRY POINT .....	7
OPERATIVE TECHNIQUE .....	9
STABILIZATION GUIDE WIRE .....	19
ANTERIOR/POSTERIOR DISTAL SCREW .....	20
LATERAL/MEDIAL DISTAL SCREW .....	24
DISTAL CROSS SCREWS.....	27
PROXIMAL LOCKING SCREW – Nail 130mm .....	30
PROXIMAL LOCKING SCREW – Nail 180mm / 250mm .....	33
SYNDESMOSIS SCREWS .....	34
INSERTION OF THE END CAP .....	38
IMPLANT REMOVAL .....	39
ORDERING INFORMATION .....	41

## PRODUCT DESCRIPTION



### ESTREMO Fibular Nail

- Right and left anatomical nail
- Made of Stainless Steel AISI 316L
- Distal diameter: 6.4 mm
- Available shaft diameters: 3.3, 3.8 mm
- Available lengths: 130, 180, 250 mm
- Anatomical bend: 3.5°
- R/L anatomical 20° position syndesmotic holes
- Screws diameter: 2.5, 3.5 mm

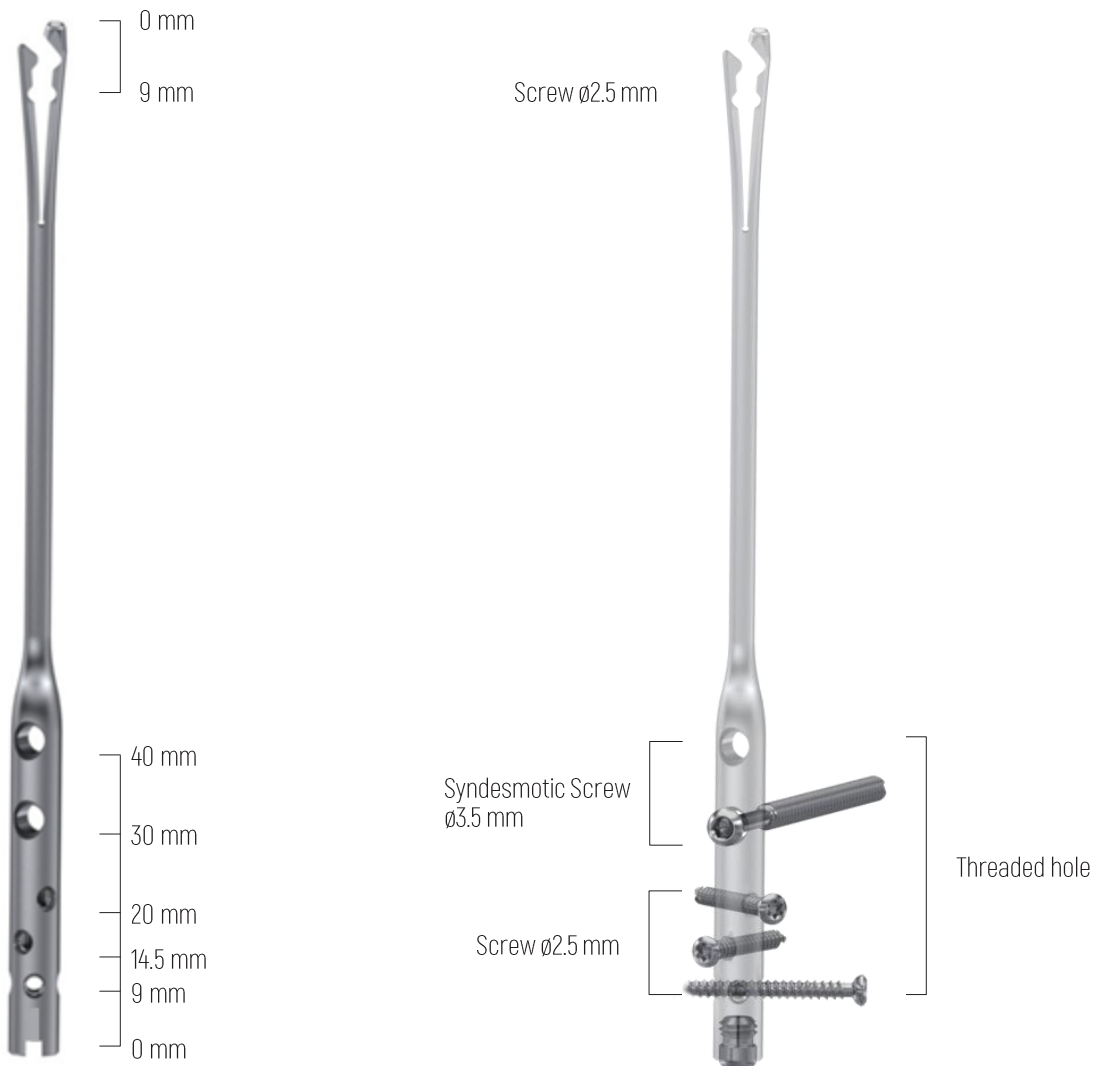

The ESTREMO Fibular Nail is distributed with the "driver" guide wire  $\varnothing 1$  mm preassembled, removal of the wire will allow deployment of the proximal tip of the nail.

The proximal tip of the nail features a patented design with wing expansion for the proximal stability.



## ESTREMO Fibular Nail: screws and caps

All ESTREMO Fibular Nail screws and caps have a T8 Torx head allowing the use of just one screwdriver.

### Screw $\varnothing 2,5\text{mm}$



- Made of SS AISI 316L
- Self-tapping
- Available lengths: from 8 to 30mm in 2mm increments
- $\varnothing 2,5\text{mm}$
- T8 Torx

### Syndesmotic static screw $\varnothing 3,5\text{mm}$



- Made of SS AISI 316L
- Self-tapping
- Available lengths: from 12 to 40mm in 2mm increments  
from 45 to 65mm in 5mm increments
- $\varnothing 3,5\text{mm}$
- T8 Torx

### Syndesmotic dynamic screw $\varnothing 3,5\text{mm}$

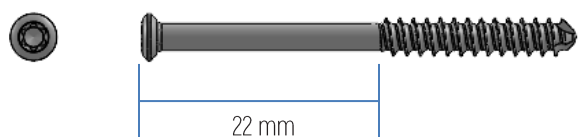

- Made of SS AISI 316L
- Self-tapping
- Available lengths: from 35 to 65mm in 5mm increments
- $\varnothing 3,5\text{mm}$
- T8 Torx

### ESTREMO Fibular Nail end cap



- Made of SS AISI 316L
- 3 available sizes for nail length increment of: 0mm, 2,5mm, 5mm
- Prevents bone growth at the apex of the nail
- Increases the height of the nail in case of excessive sinking
- T8 Torx

## SURGICAL INDICATIONS AND ENTRY POINT

### Indications

The ESTREMO Fibular Nail is intended for use in the fixation of fibula fractures and osteotomies.

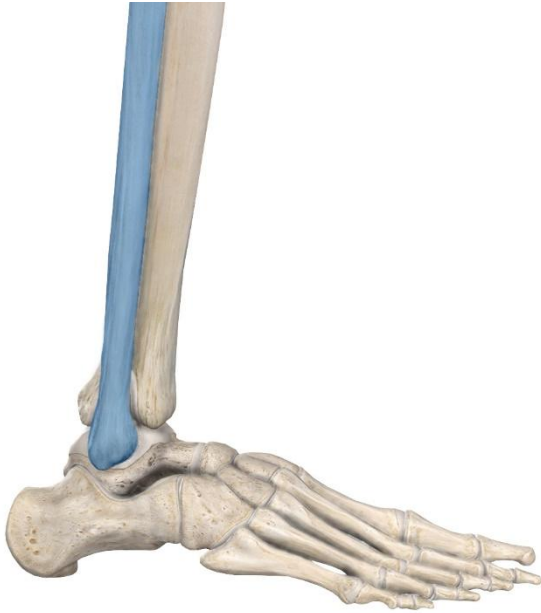

### Patient positioning

Position the patient in a supine position on the radiolucent operating table.

The use of a dedicated support to be placed under the leg to keep the limb raised by approximately 15 - 20cm is recommended.



*The steps described illustrate the operative technique with the patient in the supine position and treatment of the right limb*

## Incision and entry point



Make a linear incision approximately 1-1.5 cm distal to the lateral malleolus.

Fracture reduction can be achieved by percutaneous technique using a reduction forceps or by using a joystick.

Establish the entry point using the Guide wire trocar tip  $\varnothing 2 \times 180 \text{ mm}$ , advance the guide wire 15 - 20 mm into the distal fibula with the drill on oscillate. Supinating the foot will increase accessibility to the distal fibula.

## INSTRUMENTS REQUIRED

Code	Description
FN992018	Guide wire trocar tip $\varnothing 2 \times 180 \text{ mm}$ STERILE

## OPERATIVE TECHNIQUE

### Guide wire insertion



Through the incision, insert the Multi-hole trocar, until it contacts the cortical.

Insert the Guide wire  $\varnothing 2 \times 180 \text{mm}$  on the distal fibula cartilage, slightly medial as shown in the AP view X-ray.

Under X-Ray control in both AP and lateral planes check the positioning of the guide wire into the medullary canal.

If the guide wire is positioned in line with the intramedullary canal, continue drilling.

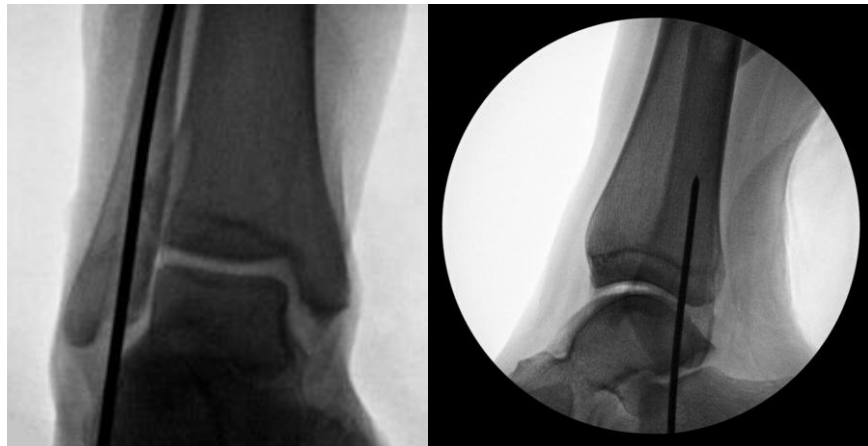

*X-ray views in AP and Lateral planes*

### INSTRUMENTS REQUIRED

Code	Description
FN992018	Guide wire trocar tip $\varnothing 2 \times 180 \text{mm}$ STERILE
FN900024	Multi-hole trocar, AO coupling
VP-92011	Handle with AO coupling

## Possible adjustments to the guide wire positioning



If the positioning of the guide wire is not correct, rotate the multi-hole trocar to place a second guide wire while holding the first guide wire in place.

Insert a second guide wire to a depth of approximately 30 mm and/or reaching a similar depth to the first one.

After correctly positioning the second guide wire, remove the first one and remove the multi-hole trocar.

### INSTRUMENTS REQUIRED

Code	Description
FN992018	Guide wire trocar tip $\varnothing 2 \times 180 \text{mm}$ STERILE

## Distal Medullary canal preparation



Holding the reduction and guide wire in place, insert on the guide wire the Tissue protection sleeve with the trocar into the incision until contact with the cortical.

Remove the trocar.

Attach the  $\varnothing 6,5\text{mm}$  cannulated drill to the cannulated T-handle for hand reaming and proceed to manually distal ream through the Tissue protection sleeve.

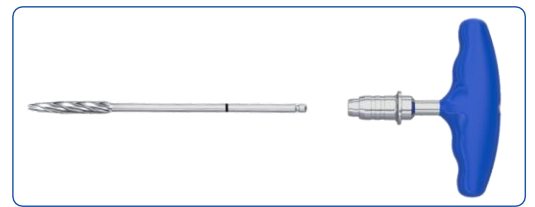

Under X-Ray control in both AP and lateral planes ream to the appropriate depth (as far as the reference on the reamer).

Remove the  $\varnothing 6,5\text{mm}$  cannulated drill.

Remove the Guide wire  $\varnothing 2 \times 180\text{mm}$ .

### INSTRUMENTS REQUIRED

Code	Description
FN900022	Tissue protection sleeve
FN900023	Trocar for tissue protection sleeve
FN980065	Cannulated drill, $\varnothing 6.5\text{mm}$ for $\varnothing 2\text{mm}$ wire STERILE
DT030970	T-handle with AO coupling

### Nail selection

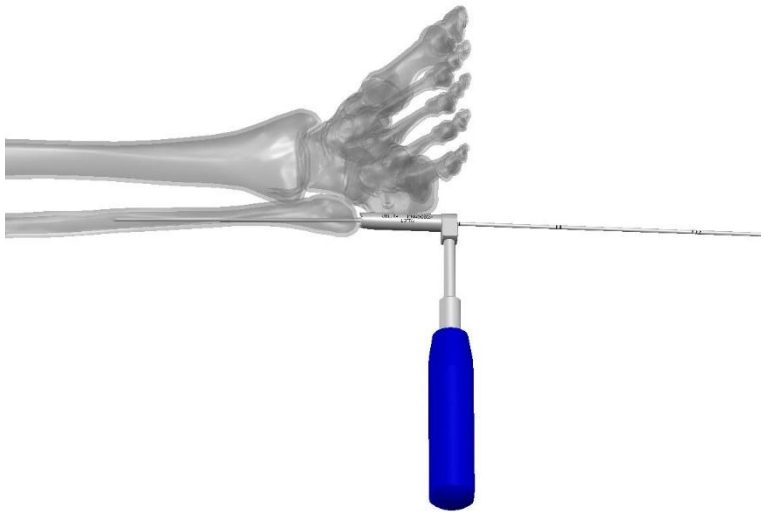

Insert the  $\varnothing 2 \times 400 \text{mm}$  Graduated guide wire through the tissue protection sleeve along the fibula.

If necessary, use the Fracture reduction wire tool to facilitate fracture reduction and the insertion of the Graduated guide wire into the correct position.

Check under fluoroscopy that the graduated guide wire is correctly inserted, the end of the wire will coincide with the tip of the nail.

Read the corresponding notch on the part of the wire that comes out of the tissue protection sleeve.

- I (one) notch indicate the nail L. 130mm
- II (two) notches indicate the nail L. 180mm
- III (three) notches indicate the nail L. 250mm

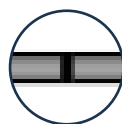
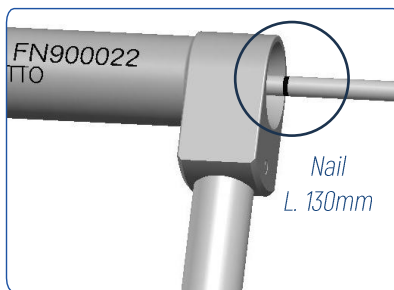

Nail  
L. 130mm

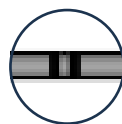

Nail  
L. 180mm

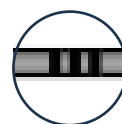

Nail  
L. 250mm

### INSTRUMENTS REQUIRED

Code	Description
FN992040	Graduated guide wire, trocar tip $\varnothing 2 \times 400 \text{mm}$ STERILE
FN900015	Fracture reduction wire (AO coupling)

## Proximal Medullary canal preparation

Fibula nail ø	Fibula nail length	Reamer ø and length	Reamer code
ø3.3 mm	130 mm	ø3.5x230mm	FN980035
ø3.3 mm	180 - 250 mm	ø3.5x350mm	FN980135
ø3.8 mm	130 mm	ø4x230mm	FN980040
ø3.8 mm	180 - 250 mm	ø4x350mm	FN980140

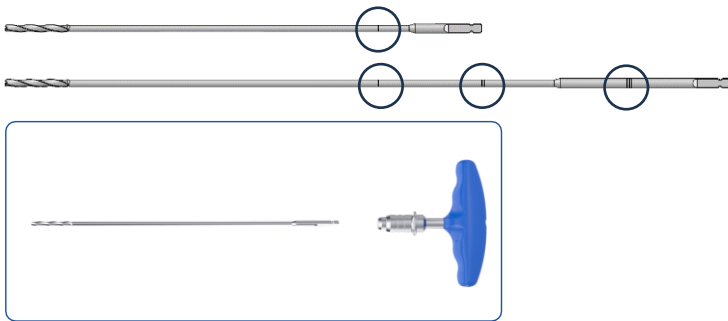

Select the right cannulated flexible drill based on nail length and diameter (see table).

*NOTE: the distal portion is the same for all nails, regardless of diameter.*

Attach the cannulated drill to the cannulated T-handle for hand reaming and proceed to proximal ream through the Tissue protection sleeve.

Under X-Ray control in both AP and lateral planes, ream to the appropriate depth of the nail to be implanted (as far as the reference on the adopted reamer).

- I (one) notch indicate the nail L. 130mm
- II (two) notches indicate the nail L. 180mm
- III (three) notches indicate the nail L. 250mm

*NOTE: the reaming ratio is line to line (1:1) with the nail length.*

Remove the tissue protection sleeve and graduated guide wire.



## INSTRUMENTS REQUIRED

Code	Description
DT030970	T-handle with AO coupling
FN980035	Cannulated flexible drill ø3.5x230mm for ø2mm wire STERILE
FN980135	Cannulated flexible drill ø3.5x350mm for ø2mm wire STERILE
FN980040	Cannulated flexible drill ø4x230mm for ø2mm wire STERILE
FN980140	Cannulated flexible drill ø4x350mm for ø2mm wire STERILE

## Nail-inserter assembly

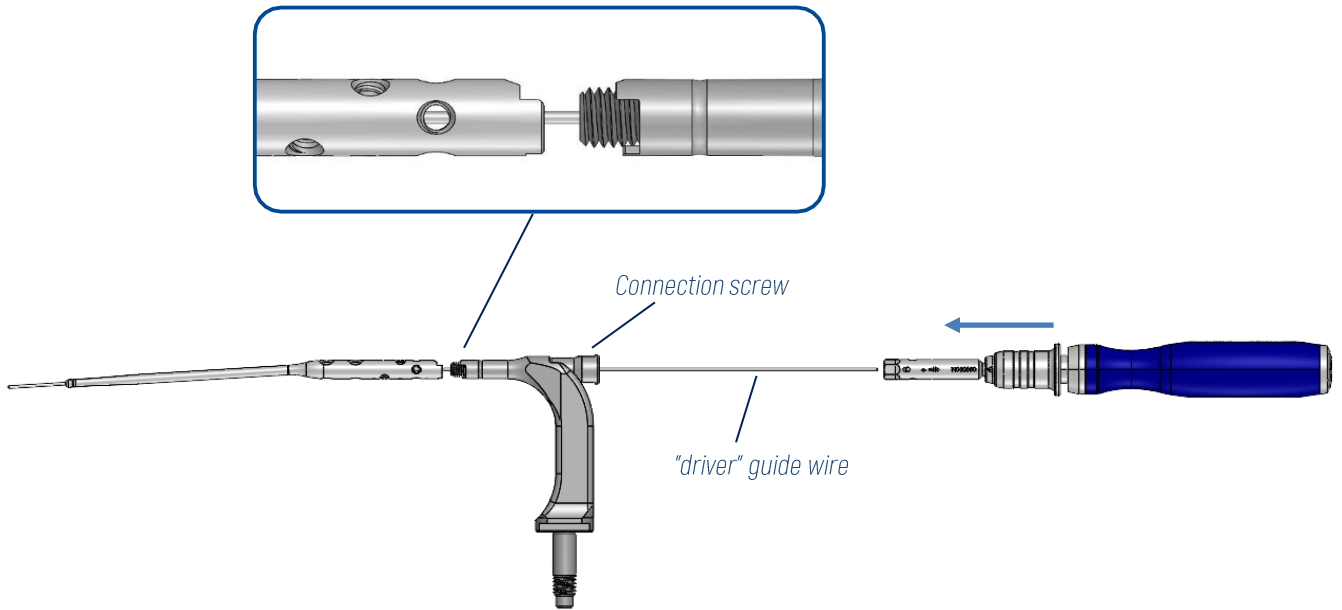

Place the nail of the length and diameter selected on the Nail inserter.

Attach the Cannulated 6mm Allen wrench to the Screwdriver handle and insert it through the "driver" guide wire.

Tighten the connection screw with Cannulated 6mm Allen wrench.

### INSTRUMENTS REQUIRED

Code	Description
FN900010	Nail inserter (ESTREMO Fibular Nail guide)
VP-92011	Screwdriver handle with AO coupling
FN900060	Cannulated 6mm Allen wrench (AO coupling)

## Nail insertion

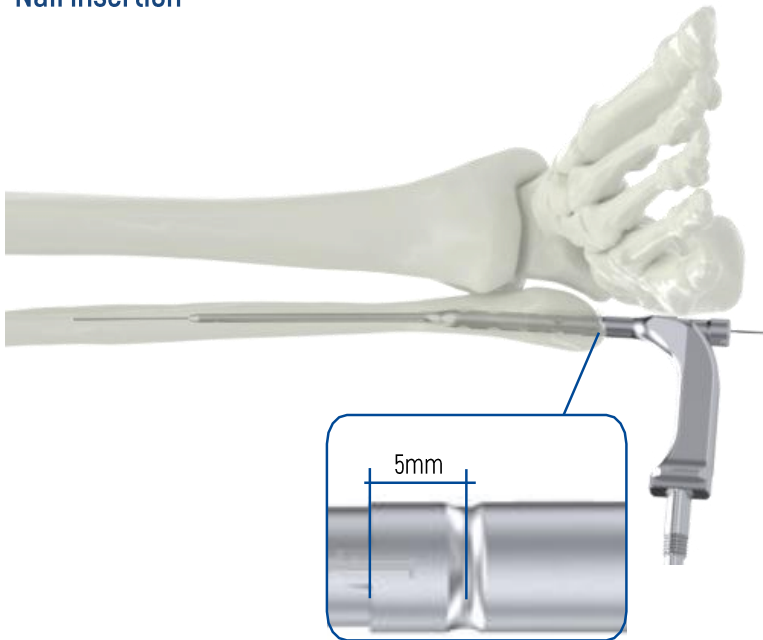

Ensure the fracture is reduced and insert the selected fibula nail into the intramedullary canal of the fibula.

An anterior-to-posterior (A/P) fluoroscopic view should be obtained to verify that the two Syndesmotic screw holes are above the tibial plafond and that the distal end of the nail has been inserted below the surface of the bone.

Syndesmotic holes is designed for syndesmotic screw positioning posteriorlateral to anteromedial.

**The nail can be rotated slightly to ensure correct plane alignment and should be confirmed under fluoroscopy prior to insertion of the screws.**

*NOTE: the indent represents 5mm away from the tip of nail.*

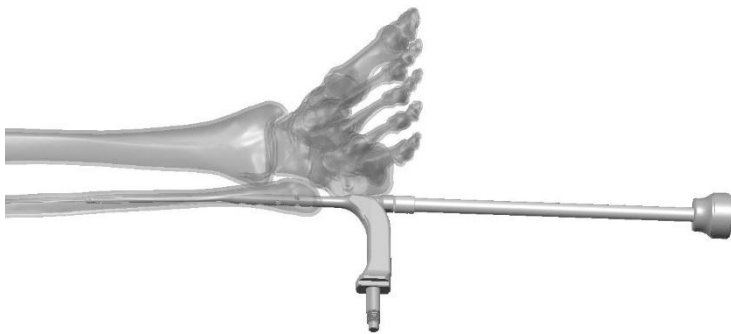
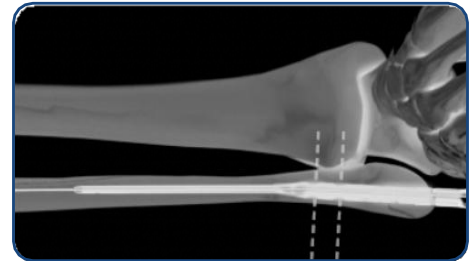
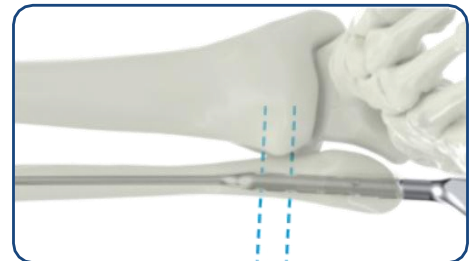
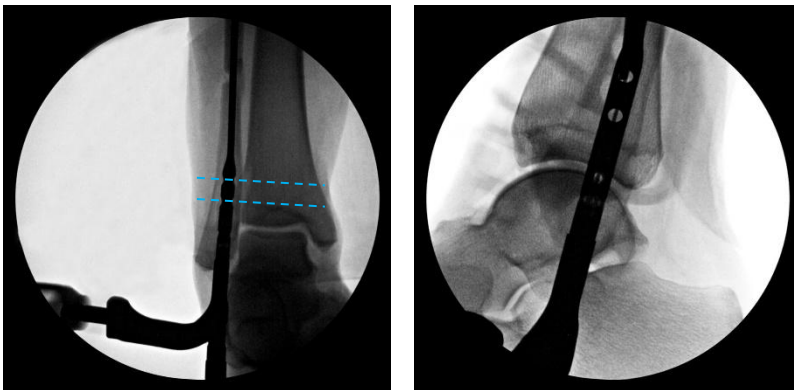

The fibula nail should pass easily down the canal without impaction. If resistance is met, it's possible lightly tap with the impactor/extractor attached to connection screw of the nail inserter.

To remove the impactor/extractor, use the spanner (9mm side) to mantein locked the connection screw of the nail inserter with the nail.

## INSTRUMENTS REQUIRED

Code	Description
FN900080	Impactor/extractor guide
38267	Diapason hammer 300gr
SF1019	Spanner 9-11mm

## Nail targeting guide



Side view Nail targeting guide



Side view A/P Targeting Guide

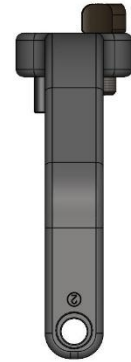

Front view A/P Targeting Guide

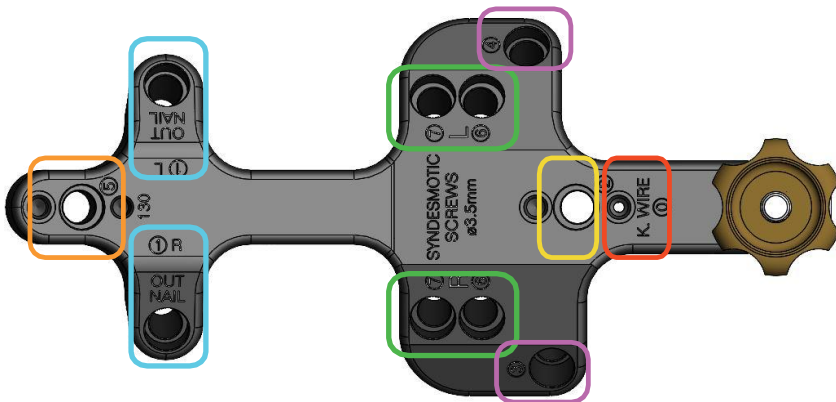

### Hole 0

K. wire position

### Hole 1 - Out Nail (right and left side)

Insertion of stabilization K. wire.

### Hole 2

Insertion of Lateral/Medial or Anterior/Posterior screw.

### Holes 3 and 4

Insertion of the distal cross screws.

### Hole 5

Insertion of the proximal screw.

### Holes 6 and 7 (right and left side)

Insertion of Syndesmosis screws.

*NOTE: the numbers marked on the Nail targeting guide correspond to the K. wires or screws site and order to be implanted.*

## Assembly of the of Nail targeting guide



Assemble the Nail targeting guide with the Nail Inserter.

Engage the Nail targeting guide to the nail inserter and tighten the gold knob firmly.

Fibula nail $\varnothing$	Fibula nail length
$\varnothing 3.3$ mm R/L	130mm
	180mm
	250mm
$\varnothing 3.8$ mm R/L	130mm
	180mm
	250mm

## Verify nail depth



The depth of the nail are determined by the correct positioning of the syndesmotomic hole and the distal end of the nail.

Insert a Guide wire  $\varnothing 2 \times 180$ mm through the "0" hole in the targeting guide marked "K. WIRE".

The tip of the wire indicates the distal end of the nail.

Under X-Ray control check the nail depth.

**WARNING:** ensure that the screws will avoid the joint space.



## INSTRUMENTS REQUIRED

Code	Description
FN992018	Guide wire trocar tip $\varnothing 2 \times 180$ mm STERILE

### Nail "driver" guide wire removal

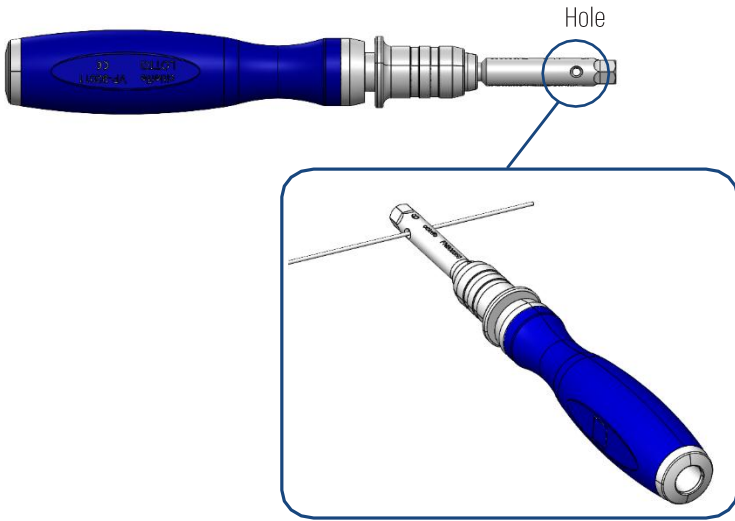

With the fibula nail inserted to the correct depth, proceed to remove the "driver" guide wire inside the nail.

It's possible to remove the "driver" guide wire using the hole on the Cannulated 6mm Allen wrench.

Removal of the nail "driver" guide wire will allow deployment of the proximal tip of the nail.



Before nail "driver" guide wire removal

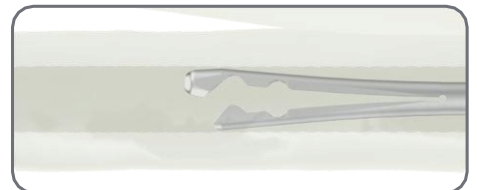

After nail "driver" guide wire removal

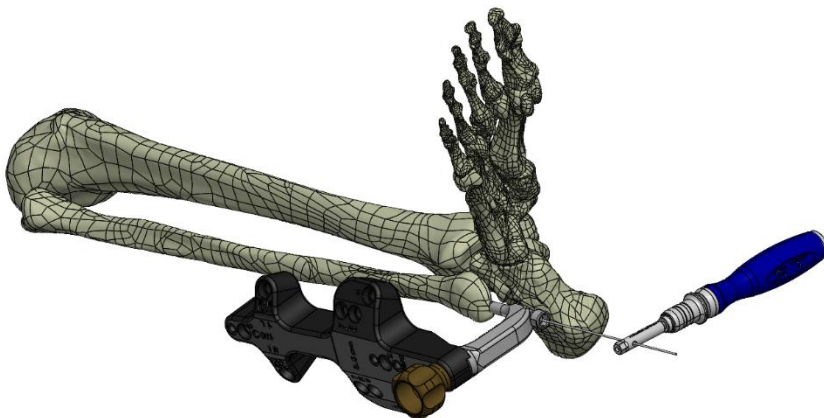

*NOTE: do not rotate the nail after the deployment*

#### INSTRUMENTS REQUIRED

Code	Description
FN900060	Cannulated 6mm Allen wrench (AO coupling)
VP-92011	Screwdriver handle with AO coupling

## STABILIZATION GUIDE WIRE

### Cannula and trocar insertion



To ensure that the position of the nail does not change, a stabilization guide wire can be inserted through the out-nail hole on the Nail targeting guide.

Insert the  $\varnothing 2\text{mm}$  Trocar into the Cannula.

To locate the incision point, introduce the trocar with the cannula into the slot marked **1 out-nail** (choose the Left or Right hole depending on the leg treated) on the Nail targeting guide until it comes into contact with skin.

Make an incision at point of contact with skin.



Initially slide down to bone.

Once cannula is in position, adjust the cannula lever parallel to the Nail targeting guide. Push the locking lever down to the recess in the Nail targeting guide and twist the lever to lock the cannula position.

Insert the Guide wire through the trocar.

Remove the Guide wire from the "0" hole.

### INSTRUMENTS REQUIRED

Code	Description
FN900020	Cannula $\varnothing 7\text{mm}$
FN900025	Trocar, $\varnothing 2\text{mm}$
FN992018	Guide wire trocar tip $\varnothing 2 \times 180\text{mm}$ STERILE

## ANTERIOR/POSTERIOR DISTAL SCREW

**WARNING: if implants the Anterior/Posterior distal screw marked "2" is not possible to insert the Lateral/Medial distal screw**

### A/P Targeting Guide assembly



To place A/P screws, engage the A/P Targeting Guide into the slot marked "2" on the Nail targeting guide and tighten the knob firmly.



Knob

Nail targeting Guide



Side view A/P Targeting Guide

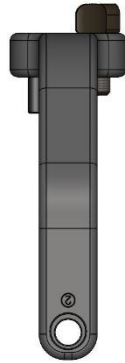

Side view A/P Targeting Guide

### INSTRUMENTS REQUIRED

Code	Description
FN900010	ESTREMO Fibular Nail guide

## Cannula and trocar insertion

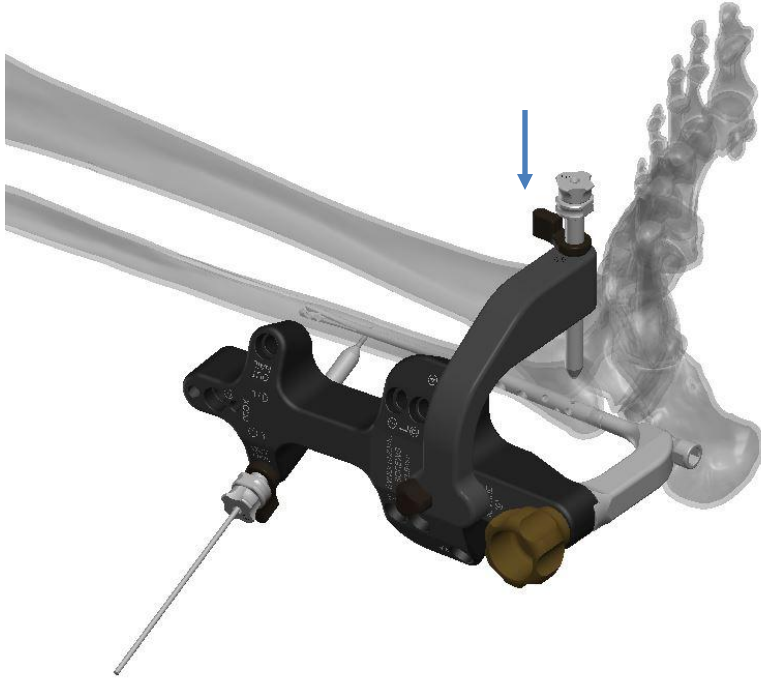

Insert the  $\varnothing 2\text{mm}$  Trocar into the Cannula.

To locate the incision point, introduce the trocar with the cannula into the slot on the A/P Targeting Guide until it encounters skin.

Make an incision at point of contact with skin.

Initially slide down to bone.

Once cannula is in position, adjust the cannula lever parallel to the Nail targeting guide.

Push the locking lever down to the recess in the Nail targeting guide and twist the lever to lock the cannula position.

## INSTRUMENTS REQUIRED

Code	Description
FN900020	Cannula $\varnothing 7\text{mm}$
FN900025	Trocar, $\varnothing 2\text{mm}$

## Screw preparation and measurement

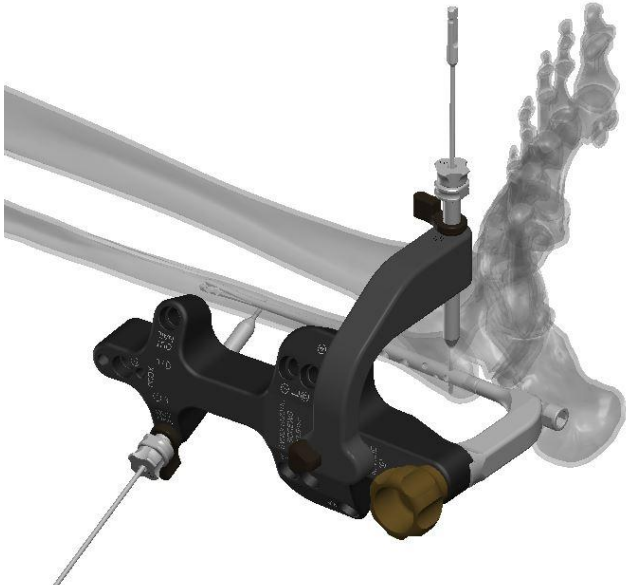

Make sure that the trocar is in contact with the lateral cortex, insert a  $\varnothing 2 \times 180 \text{mm}$  Drill bit inside the trocar and advance against the bone, drill both cortices: the tip must go beyond the second cortex of at least 2mm.

*NOTE: to ensure accurate length measurement, verify trocar is down to bone.*

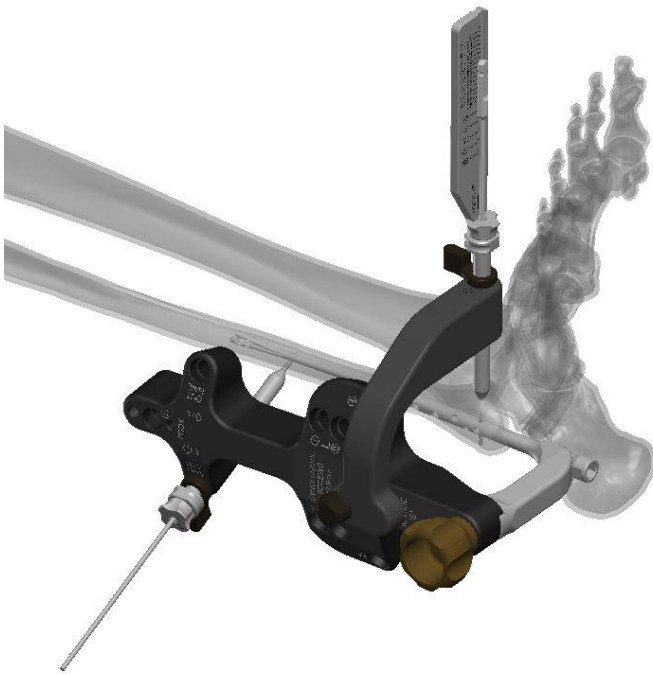

Insert the screws ruler onto the drill bit until it touches the trocar.

Measure the length of the screw on the graduated scale in correspondence at the end of the drill bit.

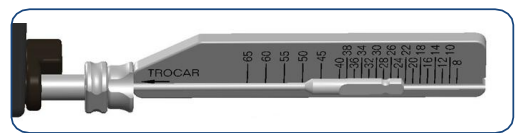

Remove the drill bit and the cannulated trocar.

### INSTRUMENTS REQUIRED

Code	Description
FN990020	Drill bit, $\varnothing 2 \times 180 \text{mm}$ AO coupling STERILE
FN900030	Screws ruler

## Screw insertion

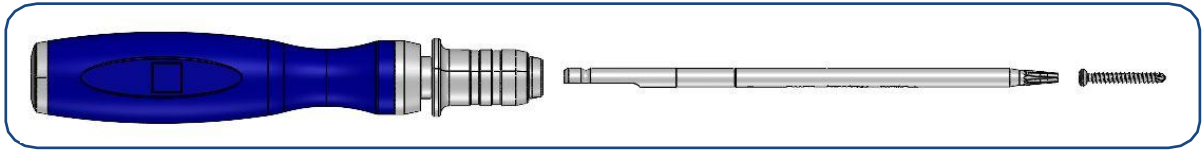

Select correct cortical screw  $\varnothing$  2.5mm.

Connect the Screwdriver handle on the Screwdriver shaft, T8.

Position the screw on the Screwdriver and secure it to the self-retaining hexalobe driver.

Insert the screw through the cannula and check the correct position under X-ray control.

Position the cannula lever parallel to the guide and remove the cannula.

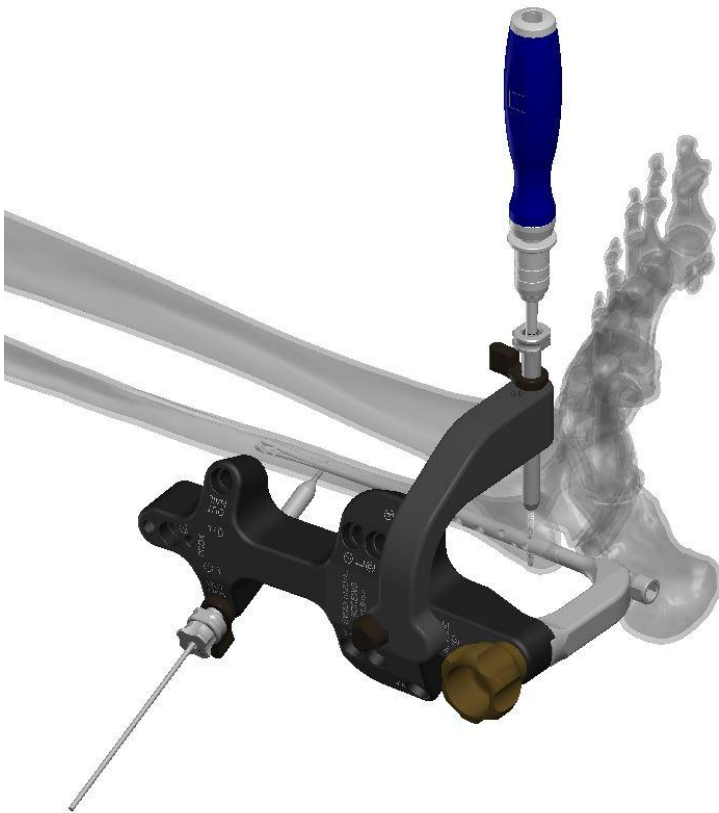

### INSTRUMENTS REQUIRED

Code	Description
VP-92011	Screwdriver handle with AO coupling
FN900040	Screwdriver shaft, T8 (AO coupling)

## LATERAL/MEDIAL DISTAL SCREW

**WARNING:** if implants the Lateral/Medial distal screw marked "2" is not possible to insert the Anterior/Posterior distal screw

### Cannula and trocar insertion

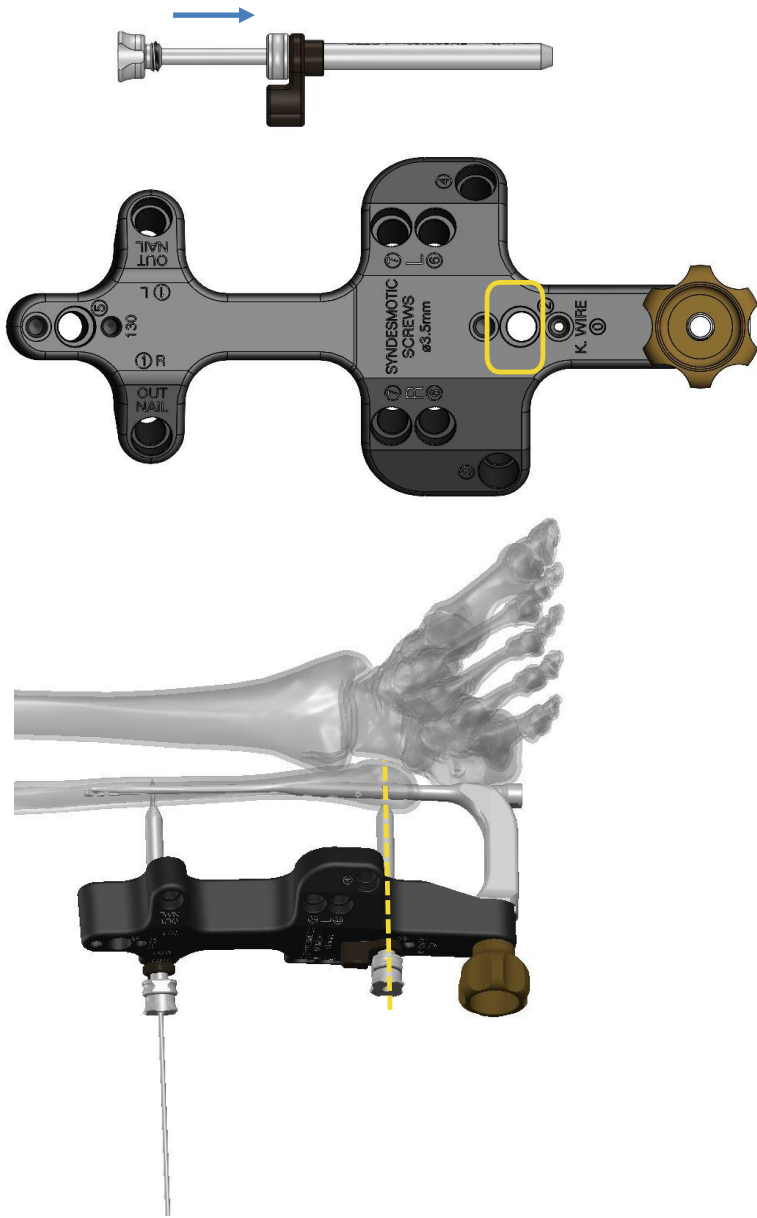

Insert the  $\varnothing 2$ mm Trocar into the Cannula.

To locate the incision point, introduce the trocar with the cannula into the slot marked "2" on the Nail targeting guide until it comes into contact with skin.

Make an incision at point of contact with skin.

Initially slide down to bone.

Once cannula is in position, adjust the cannula lever parallel to the Nail targeting guide.

Push the locking lever down to the recess in the Nail targeting guide and twist the lever to lock the cannula position.

### INSTRUMENTS REQUIRED

Code	Description
FN900010	ESTREMO Fibular Nail guide
FN900020	Cannula $\varnothing 7$ mm
FN900025	Trocar, $\varnothing 2$ mm

## Screw preparation and measurement



Make sure that the trocar is in contact with the lateral cortex, insert a  $\varnothing 2 \times 180 \text{mm}$  Drill bit inside the trocar and advance against the bone, drill both cortices: the tip must go beyond the second cortex of at least 2mm.

*NOTE to ensure accurate length measurement, verify trocar is down to bone.*



Insert the screw ruler onto the drill bit until it touches the trocar.

Measure the length of the screw on the graduated scale in correspondence at the end of the drill bit.

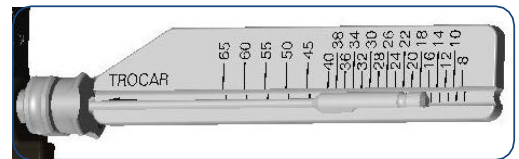

Remove the drill bit and the cannulated trocar.

### INSTRUMENTS REQUIRED

Code	Description
FN990020	Drill bit, $\varnothing 2 \times 180 \text{mm}$ AO coupling STERILE
FN900030	Screws ruler

## Screw insertion

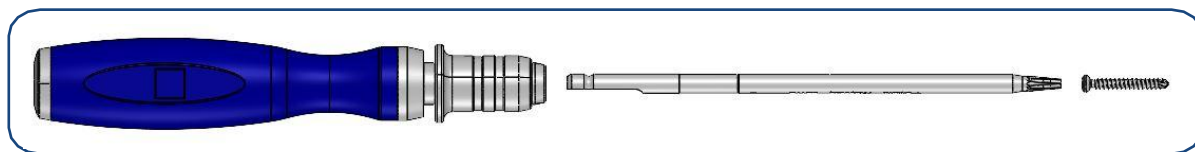

Select correct cortical screw  $\varnothing$  2.5mm.

Connect the Screwdriver handle on the Screwdriver shaft, T8.

Position the screw on the Screwdriver and secure it to the self-retaining hexalobe driver.

Insert the screw through the cannula and check the correct position under X-ray control.

Position the cannula lever parallel to the guide and remove the cannula.



### INSTRUMENTS REQUIRED

Code	Description
VP-92011	Screwdriver handle with AO coupling
FN900040	Screwdriver shaft, T8 (AO coupling)

## DISTAL CROSS SCREWS

### Cannula and trocar insertion

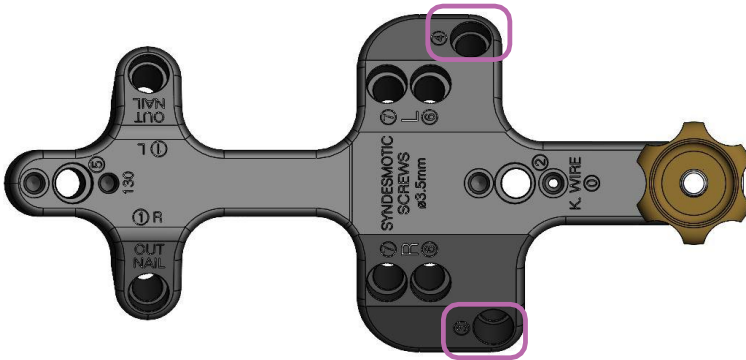

Insert the  $\varnothing 2\text{mm}$  Trocar into the Cannula.

To locate the incision point, introduce the trocar with the cannula into the slot marked "3" or "4" on the Nail targeting guide until it encounters skin.

Make an incision at point of contact with skin.

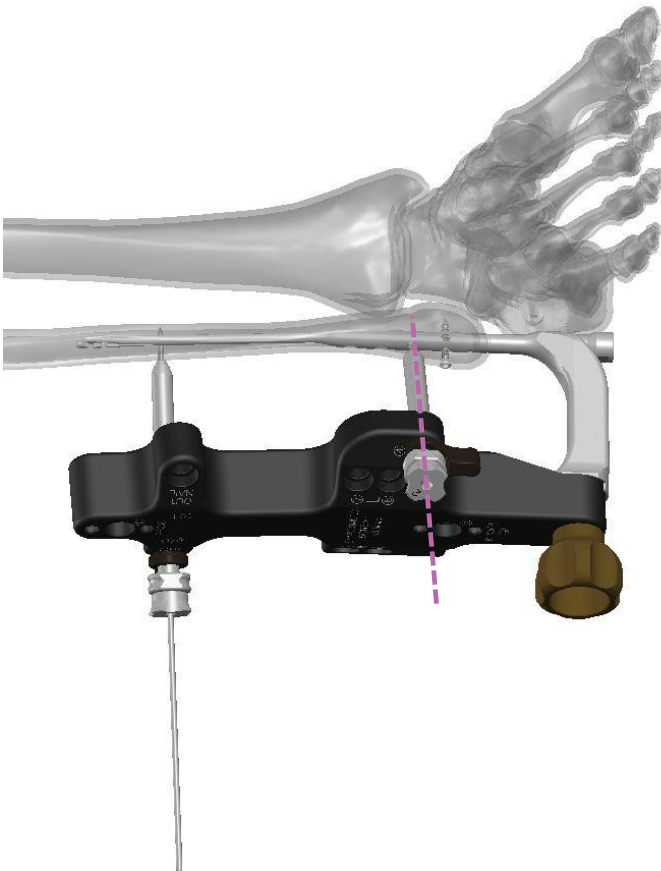

Initially slide down to bone.

Once cannula is in position, adjust the cannula lever parallel to the Nail targeting guide.

Push the locking lever down to the recess in the Nail targeting guide and twist the lever to lock the cannula position.

### INSTRUMENTS REQUIRED

Code	Description
FN900020	Cannula $\varnothing 7\text{mm}$
FN900025	Trocar, $\varnothing 2\text{mm}$
FN992018	Guide wire trocar tip $\varnothing 2 \times 180\text{mm}$ STERILE

## Screw preparation and measurement



Make sure that the trocar is in contact with the lateral cortex, insert a  $\varnothing 2 \times 180 \text{mm}$  Drill bit inside the trocar and advance against the bone, drill both cortices.

*NOTE: do not exceed the second cortex.*

*NOTE: to ensure accurate length measurement, verify trocar is down to bone.*



Insert the screws ruler onto the drill bit until it touches the trocar.

Measure the length of the screw on the graduated scale in correspondence at the end of the drill bit.

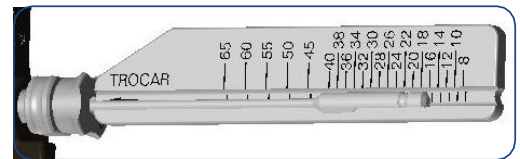

Remove the drill bit and the cannulated trocar.

### INSTRUMENTS REQUIRED

Code	Description
FN990020	Drill bit, $\varnothing 2 \times 180 \text{mm}$ AO coupling STERILE
FN900030	Screws ruler

## Screw insertion

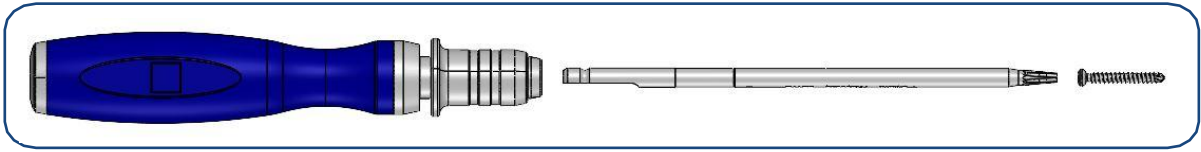

Select correct cortical screw  $\varnothing$  2.5mm.

Connect the Screwdriver handle on the Screwdriver shaft, T8.

Position the screw on the Screwdriver and secure it to the self-retaining hexalobe driver.

Insert the screw through the cannula and check the correct position under X-ray control.

Position the cannula lever parallel to the guide and remove the cannula.

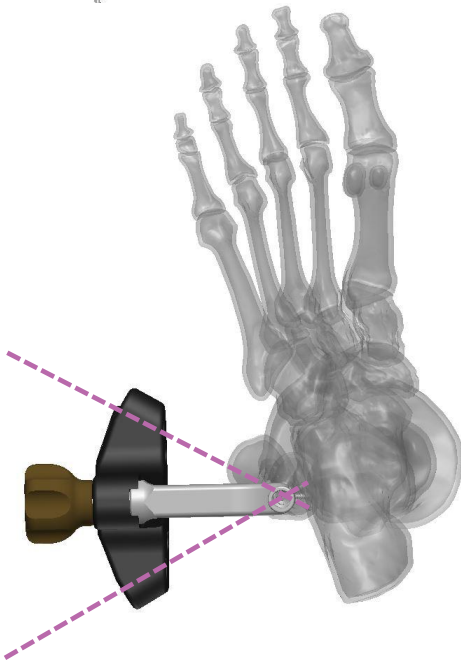

Repeat the previous steps for the second distal cross screw.

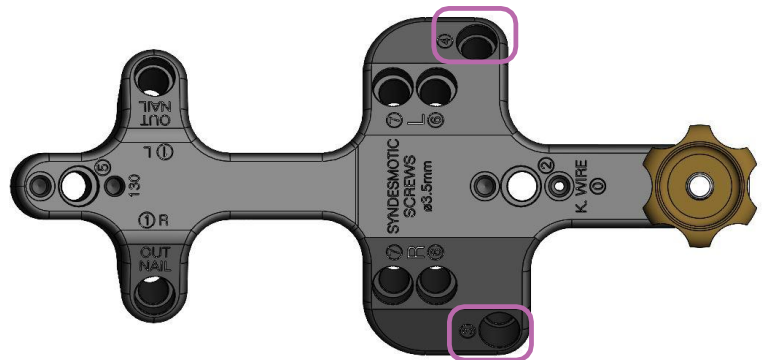

## INSTRUMENTS REQUIRED

Code	Description
VP-92011	Screwdriver handle with AO coupling
FN900040	Screwdriver shaft, T8 (AO coupling)

## PROXIMAL LOCKING SCREW – Nail 130mm

### Cannula and trocar insertion



Insert the  $\varnothing 2\text{mm}$  Trocar into the Cannula.

To locate the incision point, introduce the trocar with the cannula into the slot marked "5" on the Nail targeting guide until it encounters skin.

Make an incision at point of contact with skin.

Initially slide down to bone.

Once cannula is in position, adjust the cannula lever parallel to the Nail targeting guide.

Push the locking lever down to the recess in the Nail targeting guide and twist the lever to lock the cannula position.

### INSTRUMENTS REQUIRED

Code	Description
FN900020	Cannula $\varnothing 7\text{mm}$
FN900025	Trocar, $\varnothing 2\text{mm}$

## Screw preparation and measurement



Make sure that the trocar is in contact with the lateral cortex, insert a  $\varnothing 2 \times 180 \text{ mm}$  Guide wire inside the trocar and advance against the bone, drill both cortices: the tip must go beyond the second cortex of at least 2mm.

*NOTE: to ensure accurate length measurement, verify trocar is down to bone.*



Insert the screws ruler onto the Guide wire until it touches the trocar.

Measure the length of the screw on the graduated scale in correspondence at the end of the Guide wire.

Remove the Guide wire and the cannulated trocar.

### INSTRUMENTS REQUIRED

Code	Description
FN992018	Guide wire trocar tip $\varnothing 2 \times 180 \text{ mm}$ STERILE
FN900030	Screws ruler

## Screw insertion

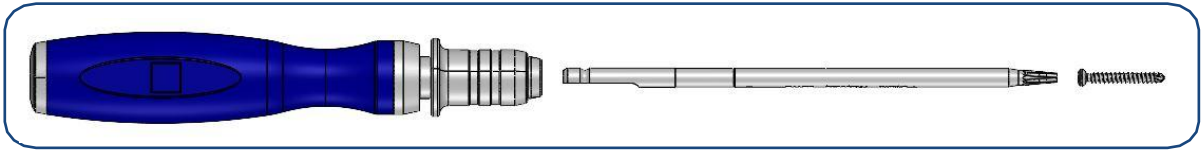

Select correct cortical screw  $\varnothing$  2.5mm.

Connect the Screwdriver handle on the Screwdriver shaft, T8.

Position the screw on the Screwdriver and secure it to the self-retaining hexalobe driver.

Insert the screw through the cannula and check the correct position under X-ray control.

Position the cannula lever parallel to the guide and remove the cannula.

Remove also stabilization Guide wire and related trocar and cannula.

### INSTRUMENTS REQUIRED

Code	Description
VP-92011	Screwdriver handle with AO coupling
FN900040	Screwdriver shaft, T8 (AO coupling)

## PROXIMAL LOCKING SCREW – Nail 180mm / 250mm

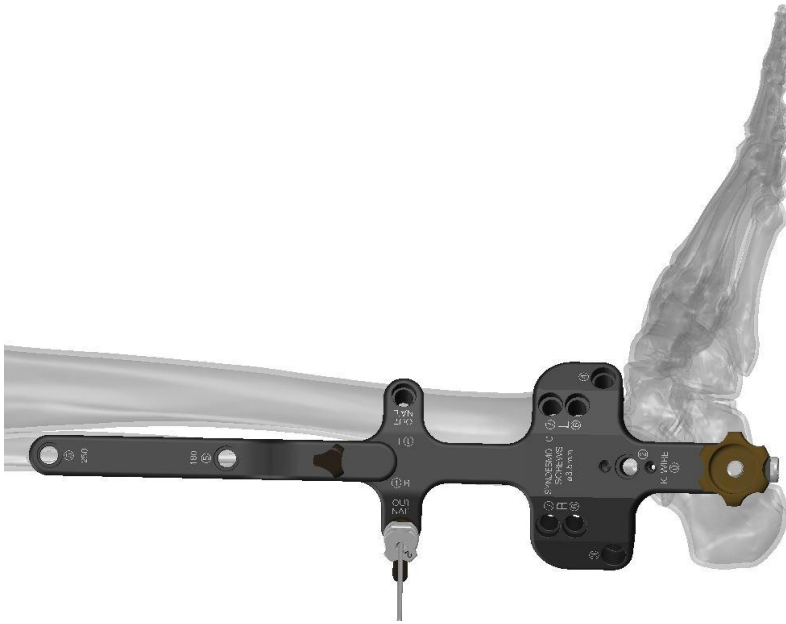

For the proximal screw insertion of the long nails (180mm or 250mm), engage the Proximal guide into the slot marked "5" on the Nail targeting guide and tighten the knob firmly.

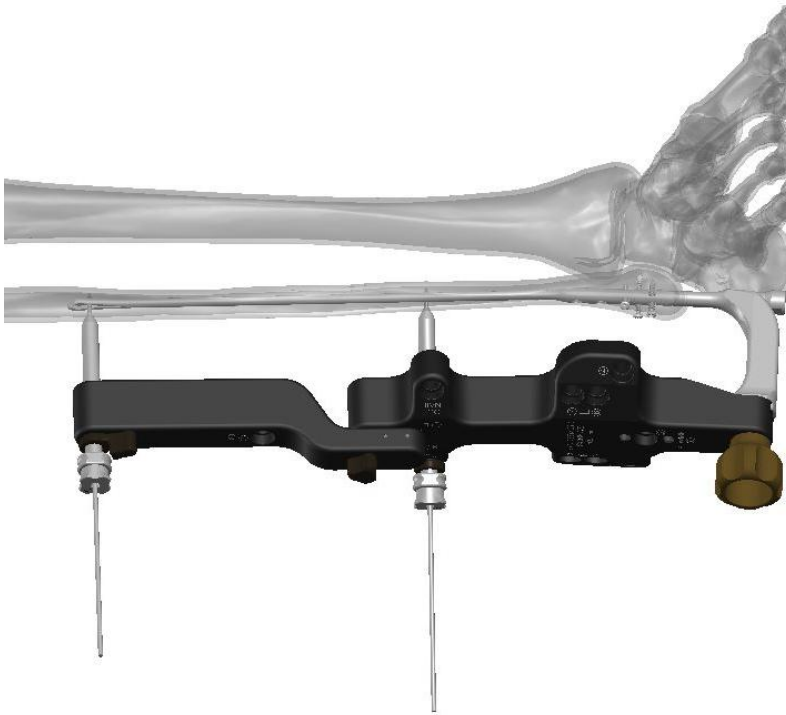

Repeat the same steps as for the proximal locking screw of the short nail.

### INSTRUMENTS REQUIRED

Code	Description
FN900012	ESTREMO Fibular Nail 180 and 250mm proximal guide
FN900020	Cannula $\varnothing$ 7mm
FN900025	Trocar, $\varnothing$ 2mm
FN992018	Guide wire trocar tip $\varnothing$ 2x180mm STERILE

## SYNDESMOSIS SCREWS

### Cannula and trocar insertion

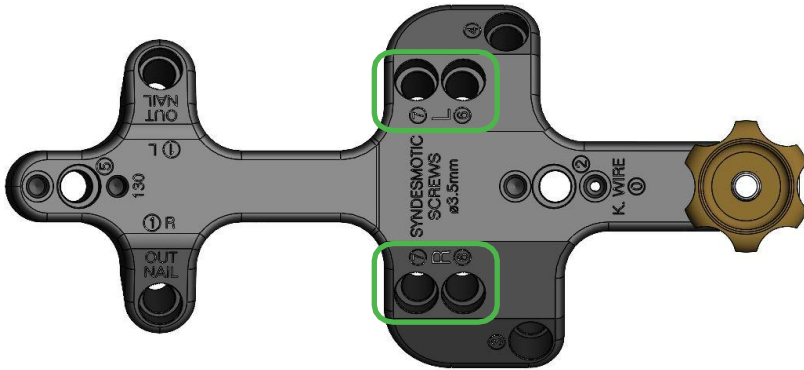

Insert the  $\varnothing 2.5\text{mm}$  Trocar into the Cannula.

To locate the incision point, introduce the trocar with the cannula into the slot marked "6" or "7" (chose the Left or Right hole depend by the leg treated) on the Nail targeting guide until it encounters skin.

Make an incision at point of contact with skin.

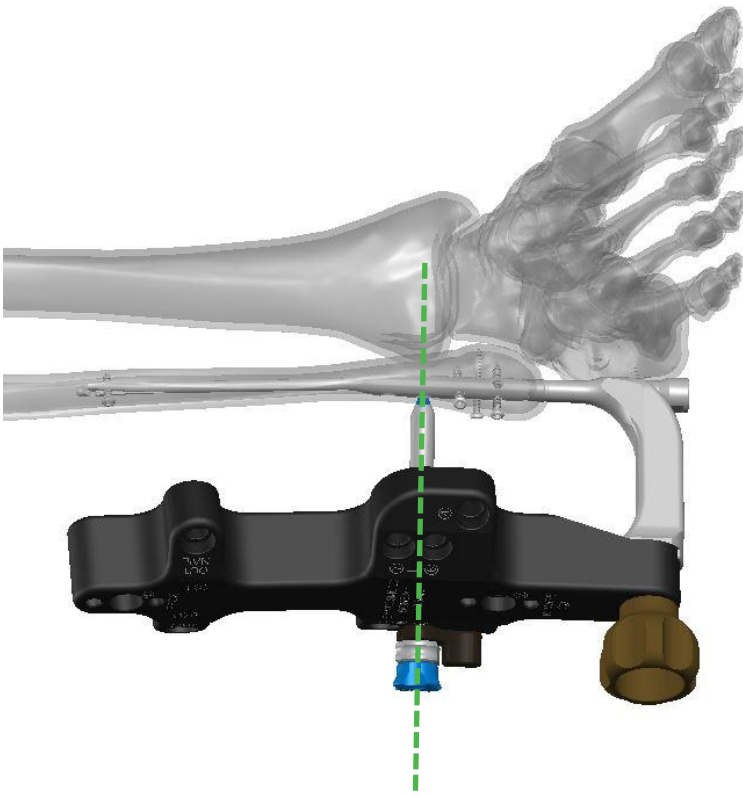

Initially slide down to bone.

Once cannula is in position, adjust the cannula lever parallel to the Nail targeting guide.

Push the locking lever down to the recess in the Nail targeting guide and twist the lever to lock the cannula position.

### INSTRUMENTS REQUIRED

Code	Description
FN900020	Cannula $\varnothing 7\text{mm}$
FN900026	Trocar, $\varnothing 2.5\text{mm}$

## Screw preparation and measurement

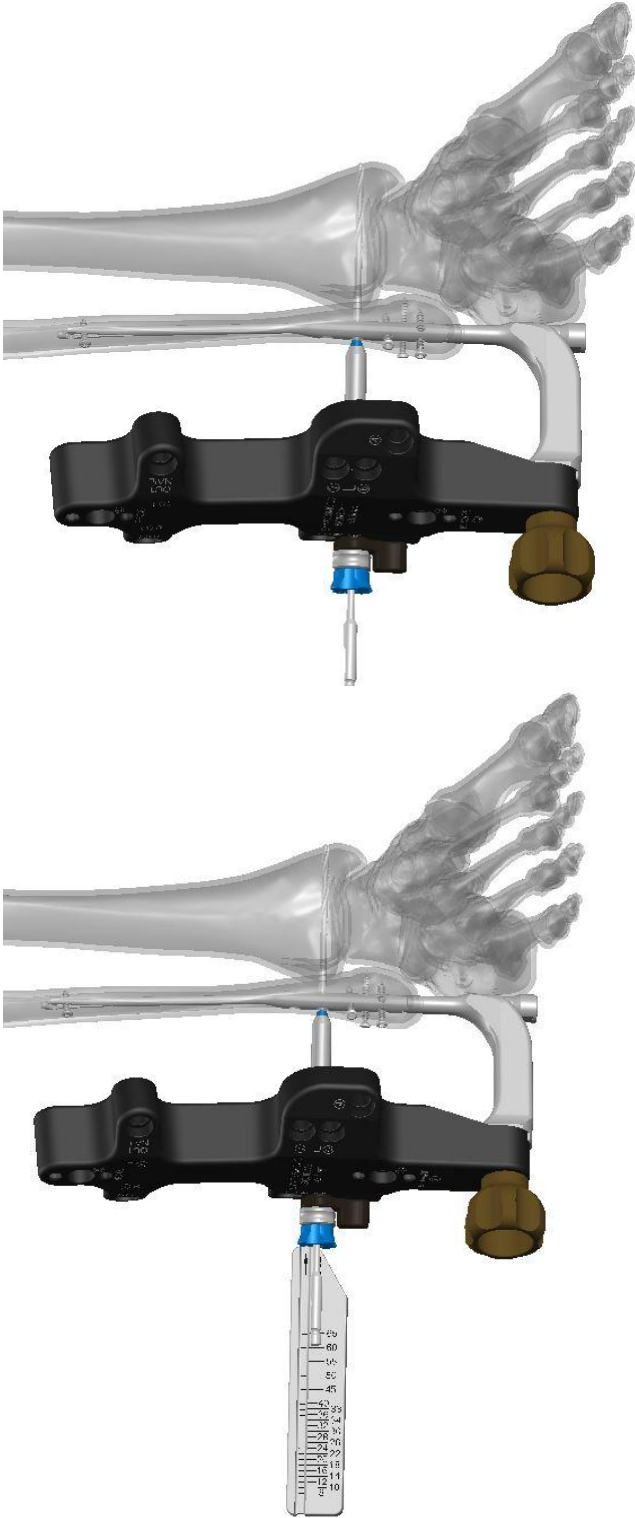

Make sure that the trocar is in contact with the lateral cortex, insert a  $\varnothing 2.5 \times 180 \text{mm}$  Drill bit inside the trocar and advance against the bone, drilling all four cortices: the tip must go beyond the fourth cortex of at least 2mm.

*NOTE: to ensure accurate length measurement, verify trocar is down to bone.*

Insert the screws ruler onto the drill bit until it touches the trocar.

Measure the length of the screw on the graduated scale in correspondence at the end of the drill bit.

Remove the drill bit and the cannulated trocar.

### INSTRUMENTS REQUIRED

Code	Description
FN990025	Drill bit, $\varnothing 2.5 \times 180 \text{mm}$ AO coupling STERILE
FN900030	Screws ruler

### Syndesmotic screw insertion

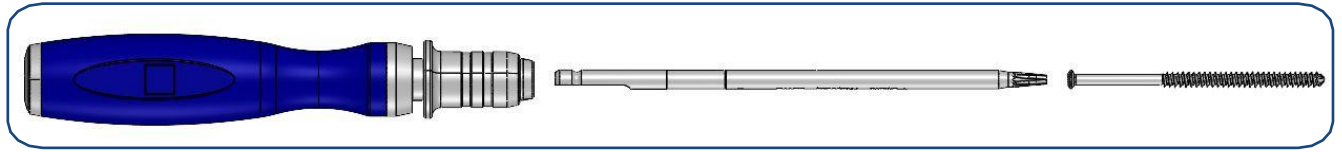

Select correct Syndesmotic screw  $\varnothing$  3.5mm (choose from static or dynamic screw option).

Connect the Screwdriver handle on the Screwdriver shaft, T8.

Position the screw on the Screwdriver and secure it to the self-retaining hexalobe driver.

Insert the screw through the cannula and check the correct position under X-ray control.

Position the cannula lever parallel to the guide and remove the cannula.

#### INSTRUMENTS REQUIRED

Code	Description
VP-92011	Screwdriver handle with AO coupling
FN900040	Screwdriver shaft, T8 (AO coupling)

## Nail targeting guide removal



Connect the Cannulated 6mm Allen wrench with the T-handle with AO coupling.

Proceed to removal of the targeting guide and the nail inserter by loosening the connection screw with Cannulated 6mm Allen wrench.

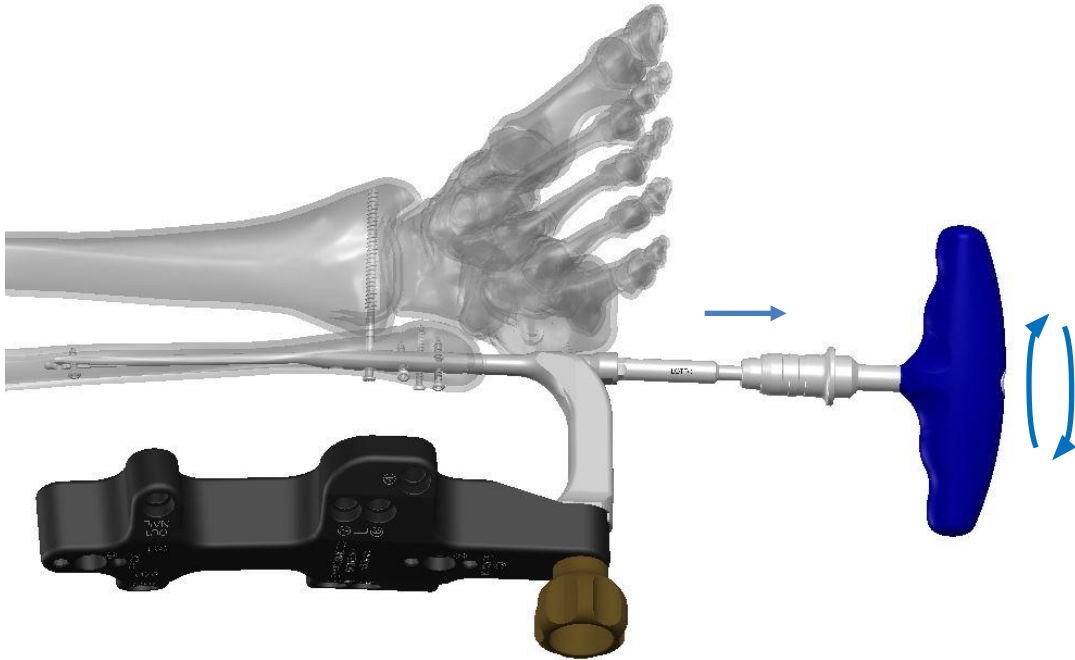

### INSTRUMENTS REQUIRED

Code	Description
FN900060	Cannulated 6mm Allen wrench (AO coupling)
DT030970	T-handle with AO coupling

## INSERTION OF THE END CAP

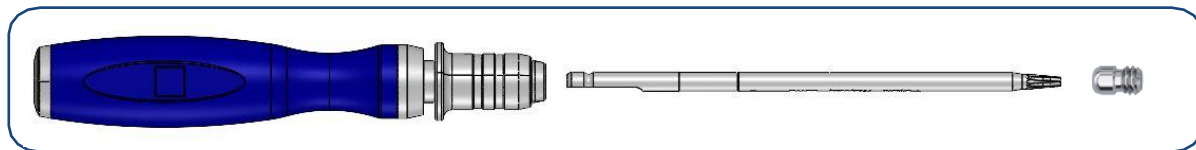

Select correct length of the end cap.

Connect the Screwdriver handle on the Screwdriver shaft, T8.

Position the end cap on the Screwdriver and secure it to the self-retaining hexalobe driver.

Insert the end cap inside the nail and rotate it clockwise.

Check the implant under X-ray control.

Suture the incision using the most suitable technique.

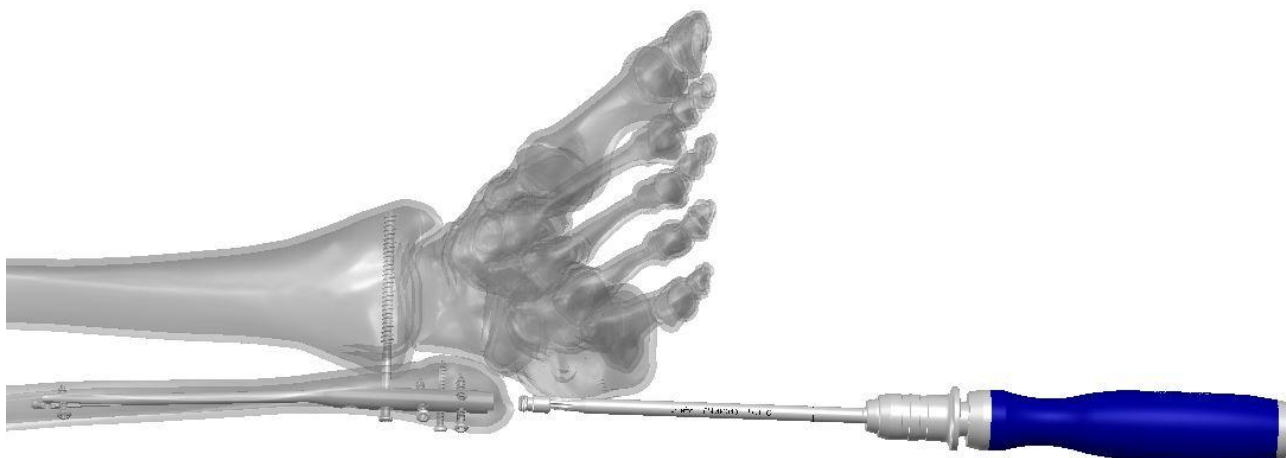

## INSTRUMENTS REQUIRED

Code	Description
VP-92011	Screwdriver handle with AO coupling
FN900040	Screwdriver shaft, T8 (AO coupling)

## IMPLANT REMOVAL

### End cap removal and extractor connection

- Perform an incision over the distal end of the nail.
- Remove any bony in-growth on the end cap.
- Connect the Screwdriver handle on the Screwdriver shaft, T8.
- Position the Screwdriver on the end cap.
- Remove the end cap by turning the screwdriver anti-clockwise.

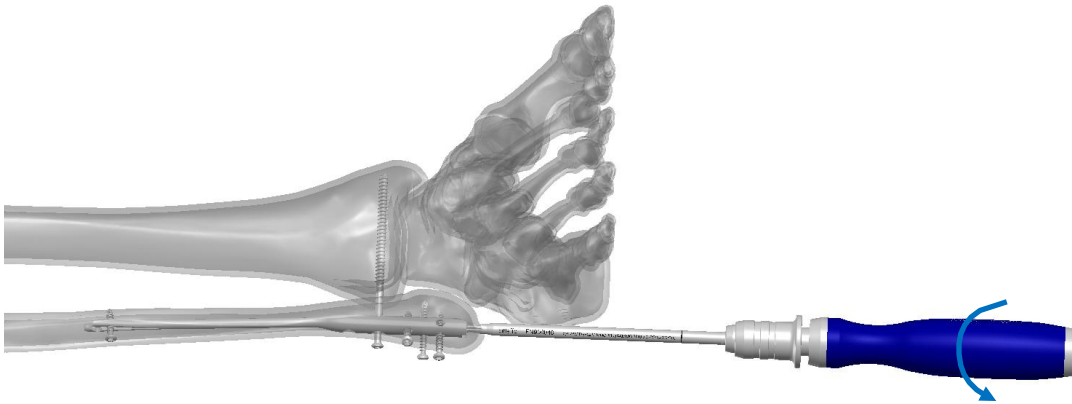

Tighten the ESTREMO Fibular Nail extractor to the nail

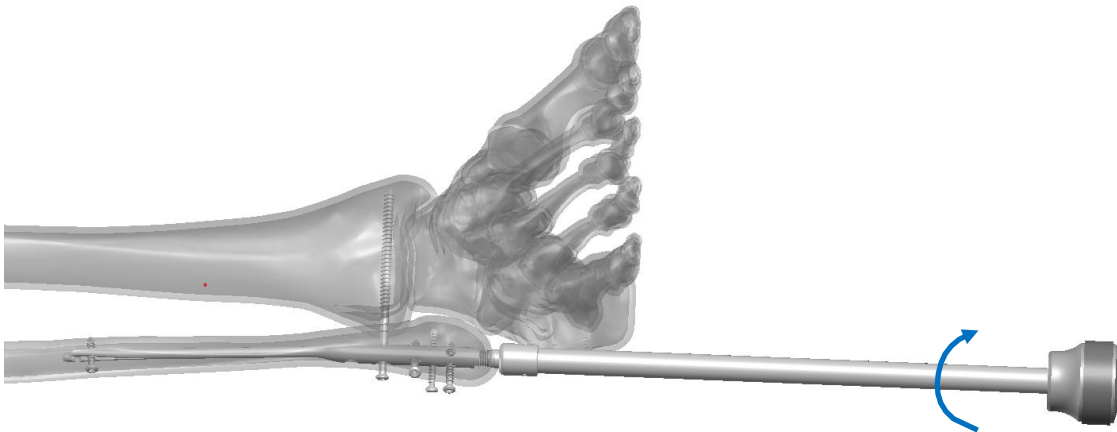

### INSTRUMENTS REQUIRED

Code	Description
VP-92011	Screwdriver handle with AO coupling
FN900040	Screwdriver shaft, T8 (AO coupling)
FN900080	Impactor/extractor guide

### Screws and nail removal

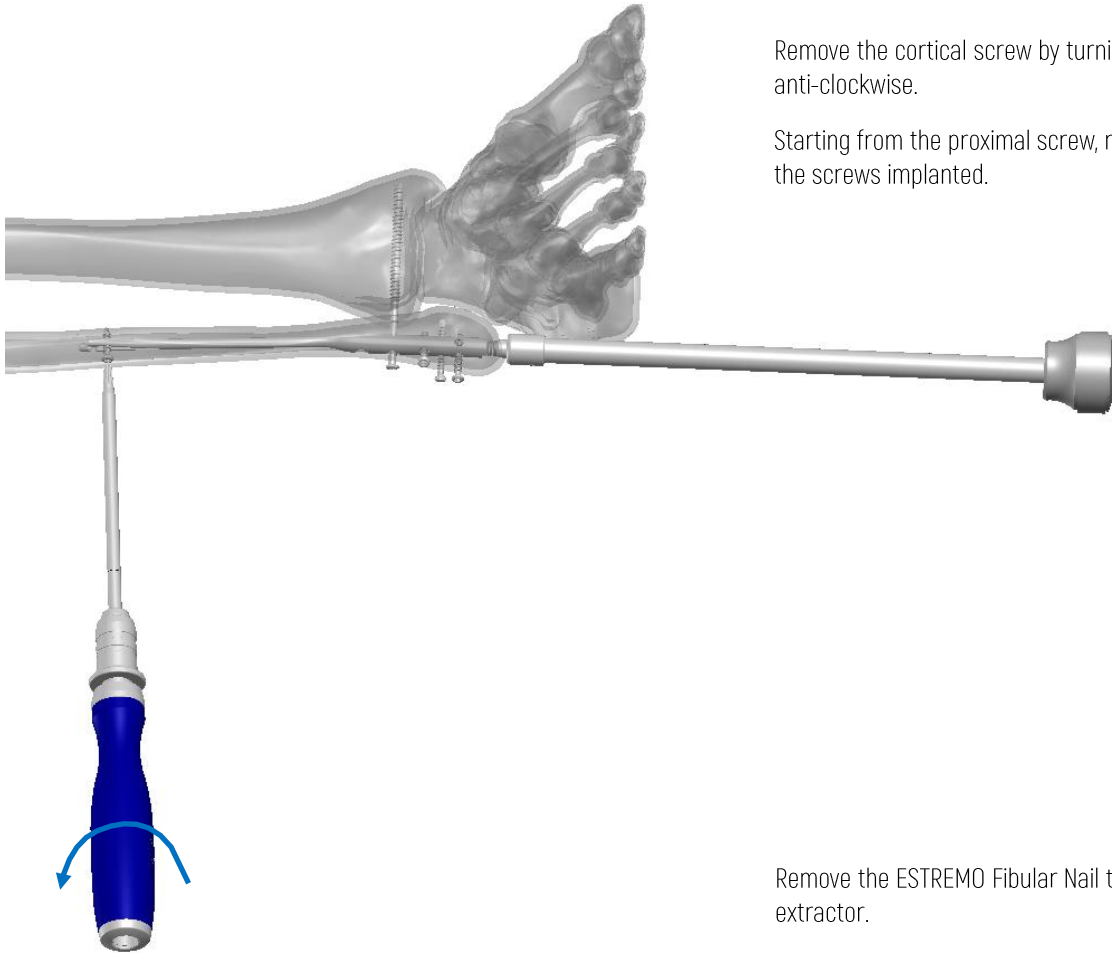

Remove the cortical screw by turning the screwdriver T8 anti-clockwise.

Starting from the proximal screw, repeat the steps for all the screws implanted.

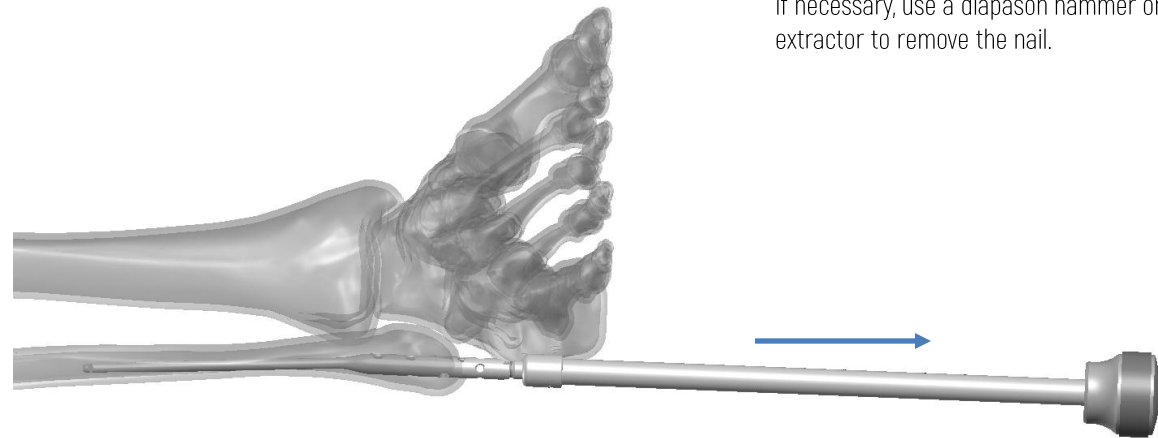

Remove the ESTREMO Fibular Nail through the nails extractor.

If necessary, use a diapason hammer on the nails extractor to remove the nail.

#### INSTRUMENTS REQUIRED

Code	Description
VP-92011	Screwdriver handle with AO coupling
FN900040	Screwdriver shaft, T8 (AO coupling)
38267	Diapason hammer 300gr

## ESTREMO Fibular Nail

STERILE



## LEFT

## RIGHT

Code	Ø (mm)	L. (mm)
FN03313L	3.3	130
FN03318L	3.3	180
FN03325L	3.3	250
FN03813L	3.8	130
FN03818L	3.8	180
FN03825L	3.8	250

Code	Ø (mm)	L. (mm)
FN03313R	3.3	130
FN03318R	3.3	180
FN03325R	3.3	250
FN03813R	3.8	130
FN03818R	3.8	180
FN03825R	3.8	250

## Screw ø2.5mm



Code	L. (mm)
FN125008	8
FN125010	10
FN125012	12
FN125014	14
FN125016	16
FN125018	18

Code	L. (mm)
FN125020	20
FN125022	22
FN125024	24
FN125026	26
FN125028	28
FN125030	30

## Syndesmotic static screw ø3.5mm



Code	L. (mm)
FN335012	12
FN335014	14
FN335016	16
FN335018	18
FN335020	20
FN335022	22
FN335024	24
FN335026	26
FN335028	28
FN335030	30

Code	L. (mm)
FN335032	32
FN335034	34
FN335036	36
FN335038	38
FN335040	40
FN335045	45
FN335050	50
FN335055	55
FN335060	60
FN335065	65

on request

### Syndesmotic dynamic screw $\varnothing 3.5$ mm

**STERILE**



Code	L. (mm)
FN435035	35
FN435040	40
FN435045	45
FN435050	50
FN435055	55
FN435060	60
FN435065	65

### ESTREMO Fibular Nail end cap



Code	Size	Nail length increment
FN000001	STD	0 mm
FN000002	2.5 mm	2.5 mm
FN000005	5 mm	5 mm

## ESTREMO Fibular Nail - Instrument set

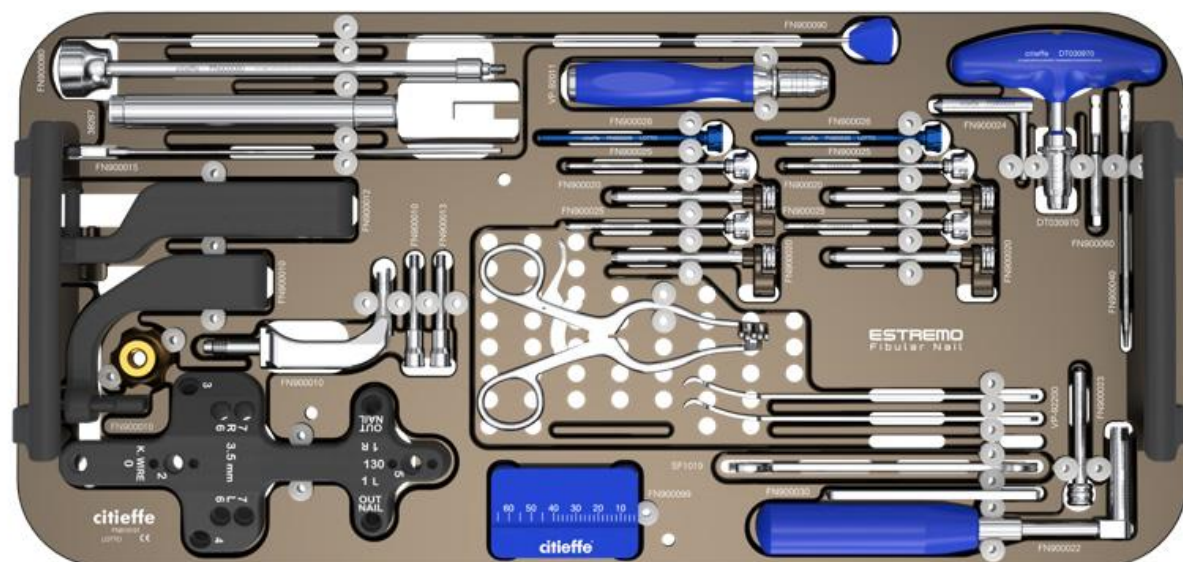

Code	Description	Q.ty
FN900010	ESTREMO Fibular Nail guide (5 parts)	1
FN900012	ESTREMO Fibular Nail 180 and 250mm proximal guide	1
FN900013	Nail connection screw (Spare parts)	1
FN900015	Fracture reduction wire (AO coupling)	1
FN900020	Cannula $\varnothing$ 7mm	4
FN900022	Tissue protection sleeve	1
FN900023	Trocar for tissue protection sleeve	1
FN900024	Multihole trocar, AO coupling	1
FN900025	Trocar, $\varnothing$ 2mm	4
FN900026	Trocar, $\varnothing$ 2.5mm	2
FN900030	Screws ruler	1
FN900040	Screwdriver shaft, T8 (AO coupling)	1
FN900060	Cannulated 6mm Allen wrench (AO coupling)	1
FN900080	Impactor/extractor guide	1
FN900090	Obturator with handle	1
FN900099	Support for $\varnothing$ 2.5 and $\varnothing$ 3.5mm screws	1
FN910100	ESTREMO Fibular Nail instrument set tray, 1 empty	1
38267	Diapason hammer 300gr	1
SF1019	Spanner 9-11mm (*)	1
DT030970	T-handle with AO coupling	1
VP-92011	Screwdriver handle with AO coupling	1
VP-92200	Hohmann retractor	2
26.3215	Weitlaner retractor 2x3 prongs sharp tips 30mm	1

(\*) The 11mm side of SF1019 is not for a fibular instrumentation.

## ESTREMO Fibular Nail - Sterile disposables

STERILE



Code	Description	Q.ty
FN980035	Cannulated flexible drill $\varnothing 3.5 \times 230$ mm for $\varnothing 2$ mm wire	2
FN980040	Cannulated flexible drill $\varnothing 4 \times 230$ mm for $\varnothing 2$ mm wire	2
FN980065	Cannulated drill, $\varnothing 6.5$ mm for $\varnothing 2$ mm wire	2
FN980135	Cannulated flexible drill $\varnothing 3.5 \times 350$ mm for $\varnothing 2$ mm wire	2
FN980140	Cannulated flexible drill $\varnothing 4 \times 350$ mm for $\varnothing 2$ mm wire	2
FN991020	Drill bit, $\varnothing 2 \times 180$ mm	2
FN991025	Drill bit, $\varnothing 2.5 \times 180$ mm	2
FN990020	Drill bit, $\varnothing 2 \times 180$ mm AO coupling	Optional
FN990025	Drill bit, $\varnothing 2.5 \times 180$ mm AO coupling	Optional
FN991518	Guide wire trocar tip $\varnothing 1.5 \times 180$ mm	Optional
FN992018	Guide wire trocar tip $\varnothing 2 \times 180$ mm	6
FN992040	Graduated guide wire, trocar tip $\varnothing 2 \times 400$ mm	2

## ADDITIONAL INSTRUMENT SET, STERILE DISPOSABLES AND IMPLANTS

Cannulated screws can be used in certain surgeries for distal fibula or ankle fractures when additional stabilization or more precise reduction of the bone fragments is required.

In these cases, the following surgical instruments, associated sterile disposables and implants can be used.

For proper use, refer to the surgical technique for Rondò cannulated screw with integral adjustable washer (TC-008A.US).

### Rondò screws $\varnothing 3-4-5\text{mm}$ - Instrument set

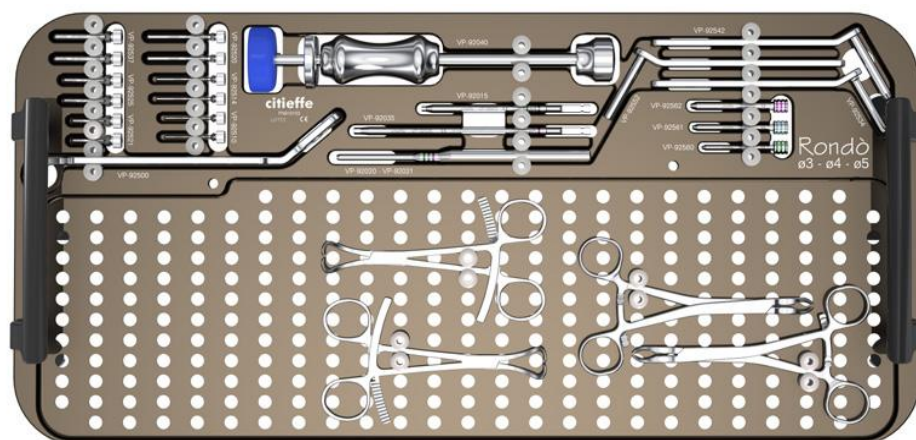

Code	Description	Q.ty
FN910102	Rondò screws $\varnothing 3-4-5\text{mm}$ instrument tray, empty	1
VP-92015	Hexagonal screwdriver shaft, 2.5mm AO connection	1
VP-92021	Ruler for Rondò screws $\varnothing 3-4-5\text{mm}$	1
VP-92035	Hexagonal screwdriver shaft, 3.5mm AO connection	1
VP-92040	Washer extractor for Rondò screws $\varnothing 3-4-5\text{mm}$	1
VP-92500	Handle for canulas, parallel wires	1
VP-92510	Trocar for wire $\varnothing 1\text{mm}$	2
VP-92514	Trocar for wire $\varnothing 1.4\text{mm}$	2
VP-92520	Trocar for wire $\varnothing 2\text{mm}$	2
VP-92521	Cannula for drill $\varnothing 2.1\text{mm}$	2
VP-92525	Cannula for drill $\varnothing 2.5\text{mm}$	2
VP-92537	Cannula for drill $\varnothing 3.7\text{mm}$	2
VP-92534	Cannula L.40mm with handle for drill $\varnothing 3\text{mm}$	Optional
VP-92542	Cannula L.45mm with handle for drill $\varnothing 4\text{mm}$	Optional
VP-92552	Cannula L.45mm with handle for drill $\varnothing 5\text{mm}$	Optional
VP-92560	Trocar L.40mm for wire $\varnothing 1.0\text{mm}$	Optional
VP-92561	Trocar L.45mm for wire $\varnothing 1.4\text{mm}$	Optional
VP-92562	Trocar L.45mm for wire $\varnothing 2.0\text{mm}$	Optional
21.4425	Lobster Claw Reduction Forceps 5.50"	2
21.4430	Reduction Clamp with teeth 5.25"	2

Rondò screws  $\varnothing 3-4-5\text{mm}$  - Sterile disposables

STERILE



Code	Description	Q.ty
VP-92721	Cannulated drill $\varnothing 2.1\text{mm}$ hole $1.1\text{mm}$ Rondò $\varnothing 3\text{mm}$	Optional
VP-92725	Cannulated drill $\varnothing 2.5\text{mm}$ hole $\varnothing 1.6\text{mm}$ Rondò $\varnothing 4\text{mm}$	2
VP-92737	Cannulated drill $\varnothing 3.7\text{mm}$ hole $\varnothing 2.2\text{mm}$ Rondò $\varnothing 5\text{mm}$	Optional
66010	K. wire trocar tip $\varnothing 1 \times 150\text{mm}$ (screws $\varnothing 3\text{mm}$ )	Optional
66014	K. wire trocar tip $\varnothing 1.4 \times 150\text{mm}$ (screws $\varnothing 4\text{mm}$ )	2
66020	K. wire trocar tip $\varnothing 2 \times 150\text{mm}$ (screws $\varnothing 5\text{mm}$ )	Optional

Rondò screw  $\varnothing 4\text{mm}$  (variable thread with single pitch)

STERILE



Code	screw $\varnothing$ mm	washer $\varnothing$ mm	Thread L. mm	Total L. mm
VP-14014	4	7.5	8	14
VP-14016	4	7.5	8	16
VP-14018	4	7.5	10	18
VP-14020	4	7.5	11	20
VP-14022	4	7.5	13	22
VP-14024	4	7.5	13	24
VP-14026	4	7.5	13	26

*on request*

Code	screw $\varnothing$ mm	washer $\varnothing$ mm	Thread L. mm	Total L. mm
VP-14028	4	7.5	14	28
VP-14030	4	7.5	15	30
VP-14032	4	7.5	15	32
VP-14034	4	7.5	16	34
VP-14036	4	7.5	17	36
VP-14038	4	7.5	17	38
VP-14040	4	7.5	19	40
VP-14045	4	7.5	19	45
VP-14050	4	7.5	22	50
VP-14055	4	7.5	22	55
VP-14060	4	7.5	27	60
VP-14065	4	7.5	27	65



# ESTREMO

## Fibular Nail

### Fibula intramedullary nail



 **Citieffe s.r.l.**  
Via Armaroli, 21, 40012 Calderara di Reno (BO) - Italy  
Tel +39 051 721850 - Fax +39 051 721870  
info@citieffe.com | www.citieffe.com

**Citieffe Inc.**  
3692 Grand Avenue #473 Miami, FL 33133  
info-usa@citieffe.com | orders-usa@citieffe.com  
www.citieffe.com/us/



For more information scan  
the QR code

YOUR DISTRIBUTOR IS